

Branched Covers of Surfaces in 4-Manifolds

Selman Akbulut* and Robion Kirby

Department of Mathematics, University of California, Berkeley, CA 94720, USA

We give an algorithm for describing, as a framed link, the p -fold branched cover of

(i) B^4 branched along the Seifert surface F of a link with $\text{int } F$ pushed into $\text{int } B^4$ (see Sect. 2);

(ii) B^4 union handles branched along $F \subset B^4$ (see Sect. 3);

(iii) S^4 branched along a surface which, except for a trivial 2-ball, lies in S^3 (see Sect. 4);

(iv) CP^2 branched along a nice surface such as a non-singular complex curve (see Sect. 5).

Along the way we show how to describe the p -fold branched cover of B^4 along the ribbon disk of a ribbon link (Sect. 3), prove that the p -fold branched cover of B^4 along a Seifert surface for the unknot is trivial (Theorem 4.1, Sect. 4), show that the Milnor fiber and various other complex surfaces can be built without 1 and 3-handles (Theorem 5.1 and corollaries), and draw the framed links for the complex surfaces, the cubic, quintic and Kummer (see Sect. 5). In Sect. 1 we fix conventions and notations.

1.

All manifolds and maps are orientable and C^∞ ; when corners occur in constructions, they are rounded in the usual way. A smooth 4-manifold is a handlebody, and it is described by drawing the attaching maps of the handles. Our 4-manifolds will have a 0-handle, some 2-handles, a 4-handle when the manifold is closed, perhaps some 1-handles, and no 3-handles.

A one handle is described by drawing the $S^0 \times B^3$ to which it is attached in $S^3 = \partial$ (0-handle). $S^0 \times B^3$ appears as two 2-spheres, $S^0 \times \partial B^3$, σ_0 and σ_1 , drawn close together; a point $s_0 \in \sigma_0$ is joined by the 1-handle to $s_1 \in \sigma_1$ iff s_1 is the reflection of s_0 across the 2-sphere equidistant to σ_0 and σ_1 and orthogonal to the great circle through the centers of σ_0 and σ_1 .

* Present address: Institute for Advanced Study, Princeton, NJ 08504, USA

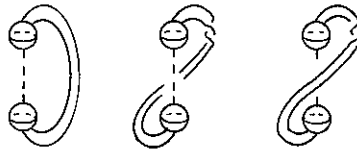

Fig. 1

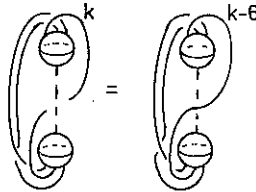

Fig. 2

A 2-handle is described (as in [K2]) by drawing the circle to which it is attached and assigning an integer (the framing) which determines the trivialization of the normal bundles, $S^1 \times B^2$, of the circle. If the circle lies in S^3 , then it has a Seifert surface, and a normal vector field to $S^1 \times 0$ which is tangent to the Seifert surface defines the 0-framing. The other trivializations are determined by the framing $\in \pi_1(SO(2)) = \mathbb{Z}$. The 2-handle defines a 2-dimensional homology class in the 4-manifold, whose self-intersection is the framing. The intersection of two such homology classes equals the linking number of their attaching circles. Thus the intersection matrix corresponds to the linking matrix. If we slide one 2-handle over another, described by band connected summing the first circle with a pushoff of the second, then the framing changes in the same way that the intersection matrix changes under a change of basis.

If a 2-handle goes over a 1-handle, then we see the attaching circle enter a B^3 at $s_0 \in \sigma_0$, proceed invisibly over the 1-handle, and reappear symmetrically at $s_1 \in \sigma_1$. However there is a difficulty with framings for 2-handles which go algebraically non-zero over a 1-handle; there is no Seifert surface to determine the 0-framing. Still we need to specify the framing by an integer. The most convenient method is to draw a dotted arc on the shortest geodesic connecting σ_0 to σ_1 . Then the 0-framing of an attaching circle of a 2-handle is computed by assuming the circle goes parallel to the dotted arc, rather than over the 1-handle, and using the Seifert surface of the new circle. See Fig. 1 for the 0-push off of some attaching circles. Then k -framing is defined as above and it transforms as above under handle sliding. It is not changed under isotopy unless an attaching circle is isotoped through a dotted arc. Then the framing changes exactly as it does when an over crossing is changed to an under crossing in a knot. Figure 2 gives an example.

F^2 usually denotes a (Seifert) surface along which branched covers are taken. CP^2 is the complex projective plane and $-CP^2$ is CP^2 with the opposite orientation; they are described by a 0-handle, a 2-handle attached to the unknot with framing ± 1 , and a 4-handle; the 0 and 2-handles give the Hopf or antiHopf disk bundle with boundary S^3 . $S^2 \tilde{\times} S^2$ denotes the nontrivial S^2 bundle over S^2 , described by a 0-handle, two 2-handles, and a 4-handle; the 2-handles are attached to the framed link $^0 \circlearrowleft \circlearrowright^1$ or to $^{-1} \circlearrowleft \circlearrowright^{+1}$.

2.

We begin by constructing the p -fold branched cover $M^4(F, p)$ of a Seifert surface F of a knot (or link) K , with $\text{int } F$ pushed into $\text{int } B^4$ and $\partial F = K \subset S^3$. First we cut B^4 along the track of the isotopy which pushed $\text{int } F$ into $\text{int } B^4$; the result is again B^4 with a thickened copy of F , namely

$$\bar{F} = \{(x, t) \in F \times [-1, 1] \mid (x, t) \sim (x, t') \text{ for } x \in \partial F, t, t' \in [-1, 1]\}$$

in ∂B^4 . To construct the p -fold cyclic branched cover, we glue together p copies of B^4 , namely B_i^4 , $i = 1, \dots, p$, by the homeomorphisms $h_i: \bar{F}_i^+ \rightarrow \bar{F}_{i+1}^-$, $i = 1, \dots, p-1$ where

$$\bar{F}_i^\pm = \{(x, t) \in \bar{F}_i \mid \pm t \geq 0\}$$

and $h_i(x, t) = (x, -t)$ (see Fig. 3). Note that it is not necessary to glue \bar{F}_p^+ to \bar{F}_1^- because this does not change the manifold (for the same reason that cutting B^4 along the track of the isotopy above does not change B^4 up to homeomorphism).

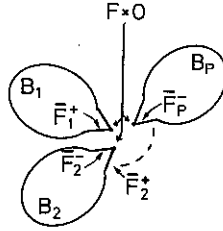

Fig. 3

Suppose for simplicity that F is connected and oriented so that it has one 0-handle and some 1-handles. First glue the B_i^4 's together (via h_i) only along the 0-handles in \bar{F}_i^\pm ; this gives B^4 again. To glue the rest of \bar{F}_1^+ to \bar{F}_2^- via h_1 , we can attach a 2-handle to B^4 for each 1-handle of F , with the attaching circle of the 2-handle equal to the core of the 1-handle in \bar{F}_1^+ union the core in \bar{F}_2^- , and the framing equal to twice the number of full twists in the 1-handle. This is done for each 1-handle and for $i = 1, \dots, p-1$, and gives a handlebody decomposition of the p -fold branched cover having only a 0-handle and some 2-handles with even framing.

It is easy to draw the framed link for $p = 2$. Figure 4 gives several examples which should make the procedure clear. Suppose there is a knot γ in a one-handle of F , e.g. the first example of Fig. 4 contains a left handed trefoil knot. The one-handle is said to have 0-twists if it lies in a Seifert surface for γ . Thus the left handed trefoil knot in Fig. 4 gives -3 full twists to that 1-handle; hence the -6 framing in the double cover.

Note that if F is non-orientable, then $H_1(B^4 - F; \mathbb{Z}) = \mathbb{Z}/2$ so that only 2-fold covers exist. The double branched cover of a Möbius band is $\mathbb{O}^{\pm 1}$, where the sign corresponds to a left or right twist in the Möbius band. It follows that the double branched cover of S^4 along RP^2 is $\pm CP^2$, for the two natural imbeddings of RP^2 in S^4 [K3].

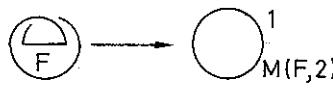
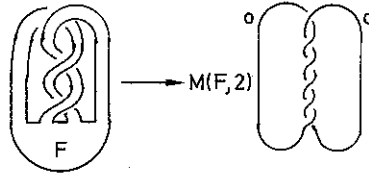
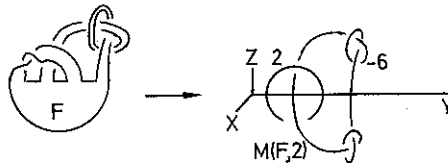

Fig. 4

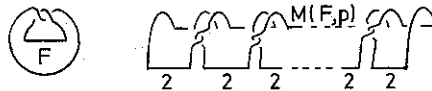

Fig. 5

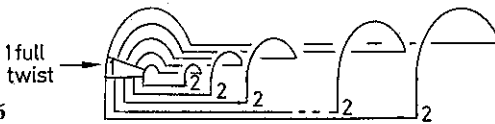

Fig. 6

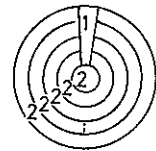

Fig. 7

When $p > 2$, the framed link is harder to draw. Each 1-handle in F gives a sequence of 2-handles which connect this 1-handle in B_1^4 to its counterpart in B_{i+1}^4 , $i = 1, 2, \dots, p - 1$. These 2-handles could be drawn as in Fig. 5.

However it is easier to think of these 2-handles as “tunnels”, and then to slide the left half of the $(p - 1)^{\text{th}}$ handle back over all the previous tunnels until it is at the left and; then do the same with the $(p - 2)^{\text{th}}$ handle, and so on. We get Fig. 6.

Doing the same steps we get the more complicated examples in Fig. 8. Note that in each case, the top half of the framed link looks like F , and is the place where all the left halves of the handles have been slid to. The bottom half is the result of folding down the right half of the handles as when passing from Figs. 6 to 7. The rule of thumb is to draw first the 2-handles gluing together B_1^4 and B_2^4 , next (and underneath) the 2-handles gluing together B_2 and B_3 , and so on, (in particular examine the first example in Fig. 8. It is the 5-fold branched cover of the trefoil knot along its fibered Seifert surface. This is known to give plumbing on the E_8 graph and to have boundary equal to the Poincaré homology sphere [KS]).

Now consider the case when F is disconnected. Suppose F is k disjoint unknotted 2-balls in B^4 . Then $H_1(B^4 - F; \mathbb{Z}) = \mathbb{Z}^k$ and we assume that our p -fold

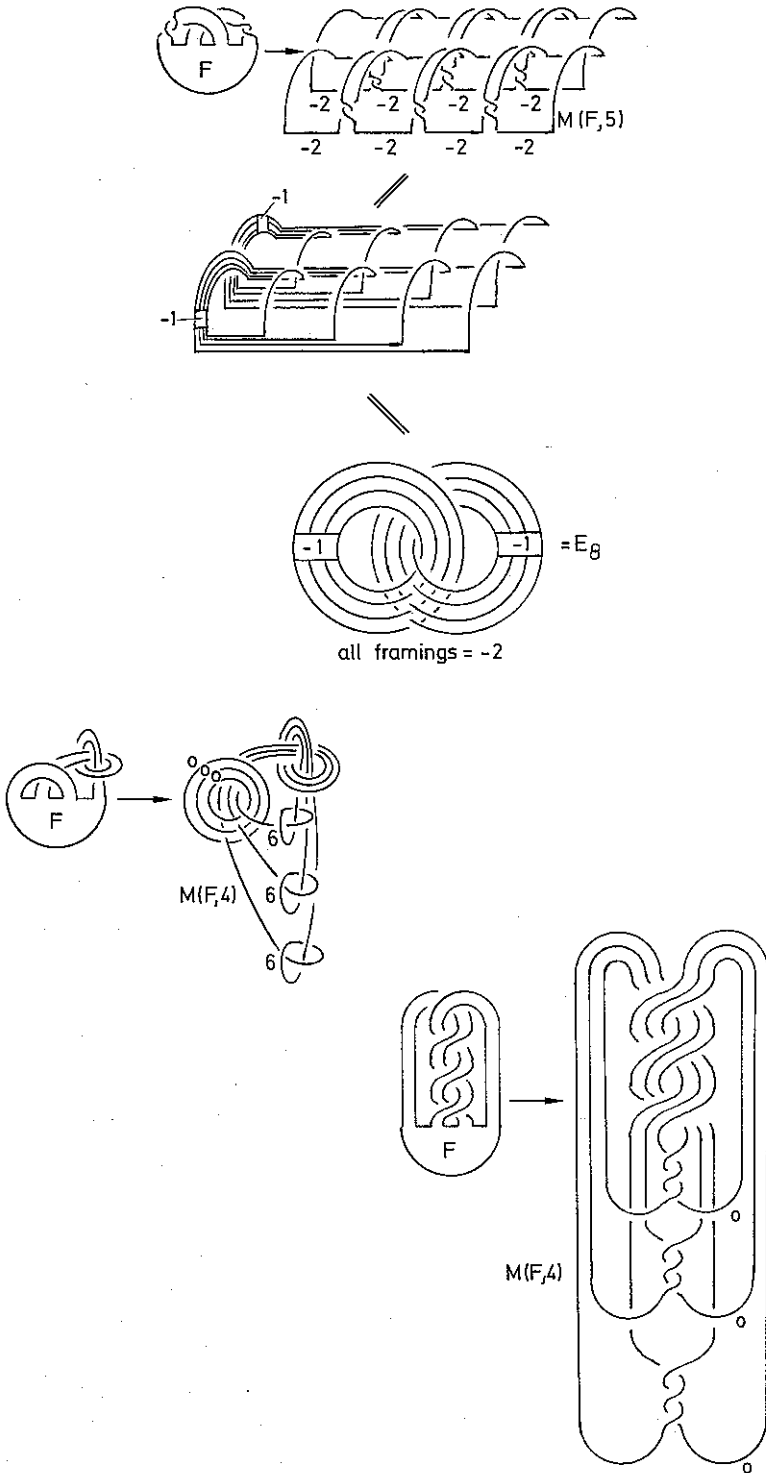

Fig. 8

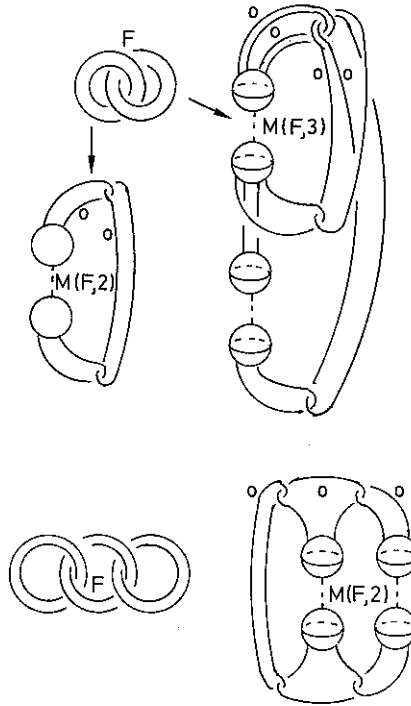

Fig. 9

cover is determined by the homomorphism $Z^k \rightarrow Z/p$ which takes each generator of Z^k to the same generator of Z/p . When we glue B_1^4 to B_2^4 along \bar{F}_1^+ and \bar{F}_2^- , we get B^4 with $k-1$ 1-handles attached. Each new B_i^4 adds $k-1$ more 1-handles so that the p -fold cover is $\#(p-1)(k-1)S^1 \times B^3$. If the homomorphism $Z^k \rightarrow Z/p$ does not take generators of Z^k to the same generator of Z/p , then \bar{F}_i^+ is glued to \bar{F}_{i+1}^- by a homeomorphism which permutes the components of F ; we leave the details to the reader.

If F consists of k disjoint surfaces in S^3 , then to form the p -fold cover, we glue together the B_i^4 , $i=1, \dots, p$ along the 0-handles of the surface as in the last paragraph, and follow by adding 2-handles to glue together the 1-handles of the surfaces as in the earlier paragraphs. Figure 9 shows some examples.

Remarks. We have constructed a commutative diagram

$$\begin{array}{ccc}
 \{\text{surfaces in } S^3\} & \xrightarrow{\Theta_p} & \{4\text{-manifolds}\} \\
 \downarrow \theta & & \downarrow \theta \\
 \{\text{links in } S^3\} & \xrightarrow{\theta_p} & \{3\text{-manifolds}\}
 \end{array}$$

where the surfaces in S^3 have boundary, Θ_p takes the p -fold branched cover after pushing the interior into B^4 , i.e. $\Theta_p(F) = M^4(F, p)$, and θ_p is Θ_p restricted to the boundary. We can ask to what extent Θ_p and θ_p fail to be monic or epic. Assume F

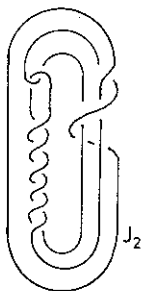

Fig. 10



Fig. 11

connected for the rest of Sect. 2. (Some of the following remarks can be better understood after reading Sect. 4.)

First consider the case $p=2$. Let τ be the generator of the $Z/2$ -action on S^3 given by 180° rotation about the y -axis union ∞ . Let M^4 be described by adding handles to a framed link L which can be drawn so that each component γ of L is invariant under τ and γ has two fixed points equal to $\gamma \cap xy$ -plane, (see for example, Figs. 4 or 23). Then a 4-manifold with boundary is in the image of Θ_2 iff it can be built from such a τ -invariant framed link. Such 4-manifolds are rare; if the boundary is S^3 , then it follows from Corollary 4.2 that such a 4-manifold is either a punctured connected sum of $(S^2 \times S^2)$'s or $(\pm CP^2)$'s.

A 3-manifold is in the image of θ_2 iff its discription as surgery on a framed link can be changed by the calculus [K2] to a τ -invariant framed link. It is difficult to decide, especially in terms of properties of the framed link, when this is possible. For example, the Borromean rings with zero framings give $T^3 = S^1 \times S^1 \times S^1$ which is not a 2-fold branched cover [F].

θ_2 is not monic. Examples are given in [BGM]. Examples can also be constructed by the following procedure: start with a τ -invariant framed link L_1 with even framings (it determines a 3-manifold which is θ_2 of an oriented surface, say F_1). Change L_1 by the calculus of framed links to a framed link which is not τ -invariant. Then change back to an even framed link L_2 , corresponding to an oriented surface F_2 . Possibly, $\partial F_1 \neq \partial F_2$. Such a construction was made by the first author in showing that the Brieskorn homology sphere $\Sigma(2, 3, 11)$ is the 2-fold branched cover of the $(3, 11)$ -torus knot, J_1 , and the knot J_2 in Fig. 10.

$\Sigma(2, 3, 11)$ lies in the Kummer surface with one component equal to the 2-fold branched cover of the usual Seifert surface F_1 of J_1 and having index-16 and second Betti number 20, and the other component obtained by adding 2-handles to the framed link in Fig. 11. It is not hard by the calculus to make this link τ -invariant, getting $\theta_2(J_2)$.

Recall that the 2-signature of a knot K , $\sigma_2(K)$, is index $(\Theta_2(F))$ for any orientable Seifert surface of K ; σ_2 is a concordance invariant [KT]. Then $J_1 \neq J_2$ because $\sigma_2(J_1) = \text{index } \Theta_2(F_1) = -16$ and $\sigma_2(J_2) = \text{index } \Theta_2(F_2) = 0$, for F_2 an orientable Seifert surface for J_2 .

To get an example where θ_2 is not monic, we can add enough copies of $\pm RP^2$ to F_1 and F_2 ; then $\Theta_2(F_1 \# l_1(\pm RP^2)) = \Theta_2(F_2 \# l_2(\pm RP^2))$ because $\Theta_2(F_1)$ and $\Theta_2(F_2)$ become diffeomorphic after connected summing copies of $\pm CP^2$. We are using here the fact that two simply connected 4-manifolds with the same boundary

become diffeomorphic after connected summing with enough copies of $\pm CP^2$; if the two 4-manifolds have even intersection forms and the same index then it is enough to connect sum with enough copies of $S^2 \times S^2$ [K2, p. 37].

To get an orientable example where Θ_2 is not monic, consider the boundary connected sum of F_1 and $-F_1, F_1 \amalg F_1$, and also $F_2 \amalg -F_2$. Note that

$$\partial(F_i \amalg -F_i) = J_i \# -J_i$$

for $i = 1, 2$ gives two distinct knots because of the unique factorization of knots into prime knots. But

$$\sigma_2(J_1 \# -J_1) = \sigma_2(J_2 \# -J_2) = 0,$$

so

$$\Theta_2(F_1 \amalg -F_1 \# l_1 T^2) = \Theta_2(F_2 \amalg -F_2 \# l_2 T^2)$$

since

$$\Theta_2(T^2 - \text{int } B^2) = S^2 \times S^2 - \text{int } B^4.$$

Lens spaces occur in a unique way as 2-fold branched covers of 2-bridge knots or links [S2]. Birman and Montesinos conjecture that a lens space occurs as a 2-fold branched cover of some other knot or link (Problem 3.26 of [K1]). If true, then it can be found by the above procedure, but this seems hard to do.

Given a framed link L (determining a 4-manifold M_L) which is τ -invariant so that $M_L = \Theta_2(F)$, we can change it by adding (or subtracting) $\bigcirc^{\pm 1}$. Then F changes by connected summing (or cutting off) $\pm RP^2$, i.e. a trivial band with a right or left half twist. If we change L by a τ -invariant handle slide (i.e. by band connected summing one circle with the pushoff of another along a τ -invariant band) then that corresponds to a handle slide on F . Thus there is a “ τ -invariant calculus” on L , fixing ∂M_L , which corresponds under Θ_2 to a calculus on F fixing ∂F .

This τ -invariant calculus is related to a graph calculus of Bonahon and Siebenmann [BS]: To a weighted tree-like graph, Γ , they assign a surface F_Γ in S^3 made up of bands with n half-twists which correspond to vertices of weight n which are plumbed together whenever two vertices are joined by a 1-simplex. Then ∂F is a knot called algebraic and they give a “canonical graph” associated with a given algebraic knot and a “calculus” of moves which relate any two graphs giving the same knot.

A graph defines a plumbing which determines a framed link L in the usual way (e.g. [K2]). L is τ -invariant and the corresponding 4-manifold M_L is the 2-fold branched cover of F . ∂M_L is a graph-manifold. Then the “graph calculus” of Bonahon and Siebenmann corresponds under 2-folds branched covers to a τ -invariant calculus for those τ -invariant links that arise from graphs.

Suppose now that p is not necessarily 2. Again the same 3-manifold can occur as the p -fold branched cover of different links. Gordon and Litherland [GL] give a general construction of such a 3-manifold: start with a link of two, unknotted components, α_1 and α_2 , whose linking number is relatively prime to p . Let β_1 be the lift of α_1 under the p -fold branched cover of S^3 along α_2 ; similarly with β_2 . Then β_1 and β_2 are knots in S^3 whose p -fold branched covers are the same

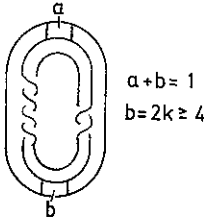

Fig. 12

$$\begin{aligned} a+b &= 1 \\ b &= 2k \geq 4 \end{aligned}$$

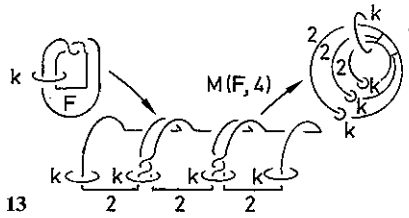

Fig. 13

manifold M^3 (since M is the p^2 -branched cover of S^3 branched over $\alpha_1 \cup \alpha_2$). If α_1 and α_2 are chosen carefully, then β_1 and β_2 are different knots; Fig. 12 gives such a link (discovered by Giller, [G]).

If $\partial F_1 = \partial F_2 = K$, genus $F_1 = \text{genus } F_2$ and are both orientable or both nonorientable, does it follow that $M^4(F_1, p) = M^4(F_2, p)$? Yes, when K is the unknot (Theorem 4.1). Yes if we add enough copies of $T^2 = S^1 \times S^1$ to F_1 and F_2 , for this adds copies of $S^2 \times S^2$ to $M^4(F_i, p)$. Otherwise, there exist knots with inequivalent minimal Seifert surfaces (e.g. [T]) and we don't know in this case that $M(F_1, p) = M(F_2, p)$, even for $p=2$. It might be easier to show that $M(F_1, p) \cup_{\text{id}} -M(F_2, p)$ decomposes as a connected sum of $(S^2 \times S^2)$'s or $(\pm CP^2)$'s.

3.

We extend the constructions of the last section to the cases where we add one and two handles to B^4 , but F remains in B^4 .

One-handles are uninteresting. The attaching map for each 1-handle can be isotoped into a small 3-ball disjoint from F , so each 1-handle lifts to p 1-handles attached in the trivial way to the branched cover of B^4 along F .

For 2-handles, we consider first the case where each 2-handle is attached to a framed circle which is disjoint from F . Then each 2-handle λ lifts to p 2-handles λ_i in the p -fold cover, one attached to each B_i^4 , $i=1, \dots, p$. Consider the elementary case in Fig. 13, and recall Figs. 5–7.

The λ_i , $i=1, 2, 3, 4$, are going to link the F_i in the obvious way. When the gluing 2-handles are slid left over the "tunnels" as in passing from Figs. 5 to 6, we find λ_1 linking all the gluing 2-handles. When we fold down the gluing handles, as in Fig. 7, and carry along the λ_i , we get Fig. 13. Note that in folding down the gluing handles, the λ_i gets rotated 180° , so that their orientations appear to change; this makes no difference here, but is important later in Sect. 5.

The reader can deduce more complicated examples from Fig. 13, because any attaching circles, (disjoint from F), can be slid up near the 1-handles of F , and then the figures corresponding to Figs. 5–7 can be drawn.

Now consider the case of a 2-handle λ which is attached to a circle C whose algebraic intersection with F is a multiple of p . Then λ lifts to p 2-handles, $\lambda_1, \dots, \lambda_p$, which are attached to the p circles C_1, \dots, C_p obtained by cutting C along F , lifting the components of C to each B_i^4 , and gluing end points together as each B_i^4 is glued

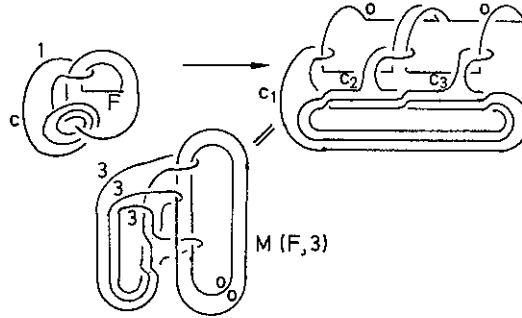

Fig. 14

to B_{i+1}^4 . Figure 14 gives an elementary example for $p=3$. The framing of C_i is computed from the equation $(\sum \lambda_i) \cdot (\sum \lambda_i) = p\lambda \cdot \lambda$, or, by symmetry $\lambda_i(\sum \lambda_i) = \lambda \cdot \lambda$ where λ_i also represents the 2-dimensional homology class represented by the handle λ_i . The equation follows from the fact that each intersection point lifts to p intersection points.

Finally, suppose that we have several 1-handles $\omega_1, \dots, \omega_r$ and several 2-handles $\lambda_1, \dots, \lambda_s$ attached to B^4 and we wish to construct the p -fold branched cover along the surface F . We are assuming that the p -fold cover of $(B^4$ minus the pushed in copy of $F)$ extends over the 1 and 2-handles.

Proposition. *This assumption is equivalent to the existence of handle slides and isotopies so that the attaching circle of each 2-handle passes algebraically through F a multiple of p times.*

Proof. Let $\partial \lambda_i \cdot F = f_i$ and let λ_i over ω_j algebraically a_{ij} times. If μ is the meridian of ∂F in S^3 , generating $H_1(S^3 - F; \mathbb{Z}) = H_1(B^4 - F; \mathbb{Z})$, then the homomorphism taking μ to the generator of \mathbb{Z}/p must extend over the handles. Each λ_i can be viewed as a homology between $f_i \mu$ and $\sum_j a_{ij} \omega_j$. First we slide the 2-handles over each other so that $\partial \lambda_1 \cdot F = f$ and $\partial \lambda_i \cdot F = 0, i \geq 2$, where $f = \text{l.c.d.}(f_1, \dots, f_r)$. Then by sliding 1-handles over each other, we can arrange that λ_1 go over ω_1 algebraically a times, and zero times over the other $\omega_j, j \geq 2$, where $a = \text{l.c.d.}(a_{11}, \dots, a_{1s})$. If we isotope one component of the attaching map of ω_1 through F m times, then we change $\partial \lambda_1 \cdot F$ to $f + ma$. Then $f + ma = np$ for some m, n , or equivalently $\text{l.c.d.}(a, p)$ divides f , exactly when we can extend the homomorphism taking μ to $1 \in \mathbb{Z}/p$ by sending each $\omega_j, j \geq 2$ to $0 \in \mathbb{Z}/p$ and sending ω_1 to $m \in \mathbb{Z}/p$. But any extension can be changed to one of this type so we are done.

Having moved the handles around so as to achieve the conclusion of the Proposition, we draw the branched cover as in the previous case. As an example, consider Fig. 15 [and remember what framing means when there are 1-handles present (see Sect. 1)]. It is necessary to slide one foot of the one handle through F and then to branch. The framings are calculated as though there were no 1-handles present. Some handle slides and cancellation give $L_0(3, 2) \times I$, where $L_0(3, 2)$ is the punctured lens space.

This example was chosen because it is the 2-fold branched cover of B^4 , branched along the standard ribbon for the square knot. In general, let D be a

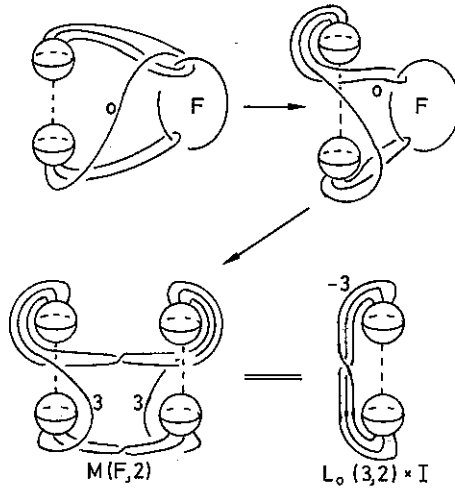

Fig. 15

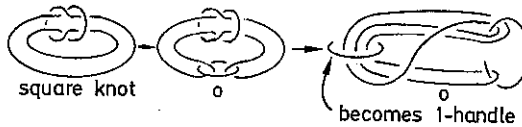

Fig. 16

ribbon disk in B^4 . Then (B^4, D) is pairwise diffeomorphic to $(B^4 \cup 1 \text{ and } 2\text{-handles, } B^2)$. In other words, by choosing a non-standard handlebody for B^4 , D can be seen as an unknotted B^2 in this picture. (This can be visualized by generalizing the following physical example in one lower dimension. Imagine a thick wire in a bathtub; as the water level rises, a water 1-handle is added whenever a wire 0-handle is passed, and a water 2-handle is added on passing a wire 1-handle.) In the case of the square knot, we first see (by letting water out and passing a saddle in D) that the square knot splits into the unlink with a 2-handle appearing (Fig. 16). An isotopy, followed by passing a minimum of D (giving a 1-handle) gives the first picture in Fig. 15.

4.

Let F be a surface with s_0 0-handles, s_1 1-handles and s_2 2-handles, where we assume handles have been cancelled if possible. The intersection form on $H_1(F; \mathbb{Z}/2)$ has rank r and nullity n , so we can divide the s_1 1-handles into r (resp. n) 1-handles which form a basis for the non-singular (resp. singular) part of the form. Note that s_0 is the number of components of F , the number of components of ∂F is $s_0 + n - s_2$, and the rank r is even in the orientable case.

If the number of components of an orientable surface F is greater than one, i.e. $s_0 = \text{rank } H_1(B^4 - F; \mathbb{Z}) > 1$, then throughout this section we will wish to assume:

(*) the p -fold cover is determined by the homomorphism which takes each generator of $H_1(B^4 - F; \mathbb{Z})$ to the same generator of \mathbb{Z}/p .

Theorem 4.1A (The orientable case). *Let F be an orientable surface in ∂B^4 and suppose that ∂F is the unlink (of $s_0 + n - s_2$ components). Then (assuming $(*)$) the p -fold branched cover of B^4 along F (with $\text{int } F$ pushed into $\text{int } B^4$) is*

$$Q = B^4 \# \left[\# (s_0 - 1)(p - 1)S^1 \times B^3 \right] \# \left[\# n(p - 1)S^2 \times B^2 \right] \# \left[\# s_2(p - 1)S^3 \times B^1 \right] \\ \# \left[\# \frac{1}{2}r(p - 1)S^2 \times S^2 \right].$$

Remarks. It should be evident that the 4 kinds of summands of Q come from the 4 kinds of handles in F . In the simple case of a connected Seifert surface of genus $g = \frac{1}{2}r$ for the unknot, Q is just a punctured connected sum of $g(p - 1)$ copies of $S^2 \times S^2$.

Proof. The case where F is s_0 0-handles has been covered in Sect. 2. Now suppose that $F = S^2$. We cut B^4 open along $S^2 \times [0, 1]$, which is the track of the isotopy pushing S^2 into B^4 . We glue together p copies of B^4 along thickened S^2 's. There is only one way to glue, up to isotopy and the result is $\# (p - 1)S^3 \times B^1$. It helps later to understand the gluing as follows: to glue two B^4 's together along thickened S^2 's, we first use a 1-handle to glue the 0-handles of the S^2 's together and then a 3-handle to glue the 2-handles of the S^2 's together. The 1-handle cancels one of the B^4 's so we are left with B^4 and a 3-handle which is $S^3 \times B^1$. With this interpretation it should become clear that the theorem holds when F is a disjoint union of 2-balls and 2-spheres, i.e. for $r = n = 0$.

Next, we span each component of ∂F with a 2-ball D_i , $i = 1, \dots, s_0$, in S^3 . We can assume that F intersects each D_i transversely in circles. Let β_1 be an innermost circle and observe that it bounds a 2-ball B_1 in D_i whose interior is disjoint from F . Surger F along β_1 using B_1 and call the result F_1 . Note that we can obtain F from F_1 by surgering F_1 along a 0-sphere λ_1 using the arc it bounds which is just a normal fiber to B_1 . We continue to surger innermost circles in this way, obtaining a sequence F_i and λ_i , $i = 1, \dots, l$.

$\bar{F} = F_l \cup D_1 \cup \dots \cup D_{s_0}$ is a closed surface in S^3 , so by the loop theorem, there is a non-trivial circle β_{l+1} in \bar{F} which bounds an imbedded 2-ball B_{l+1} in the complement of \bar{F} . We surger along β_{l+1} to get F_{l+1} . We continue applying the loop theorem and surgering until \bar{F} is a union of 2-spheres. Thus we have reduced F to F_m , a collection of punctured 2-spheres, and we can regain F by surgering, in reverse order, a collection of 0-spheres λ_i (using the arc normal to B_i), for $i = 1, \dots, m$.

Because F_m lies in \bar{F}_m , a collection of disjoint imbedded 2-spheres, it is easy to see that the 1-handles of F_m are untwisted, unknotted and unlinked; each contributes $\# (p - 1)S^2 \times B^2$ to the branched cover. Assuming the theorem for F_p , we shall prove it for F_{i-1} . To get F_{i-1} , we surger F_i along the 0-sphere λ_i using an arc α with endpoints $\{\alpha_0 \cup \alpha_1\} = \lambda_i$. The proof now breaks into several cases, depending on whether or not α_0 and α_1 belong to different components of F_i and whether or not these components are closed.

Suppose first that α_0 and α_1 belong to the same component of F_i and that this component has boundary. Then the picture for F_{i-1} looks like that for F_i except for a pair of 1-handles as drawn. One of the 1-handles follows α , but the other is a

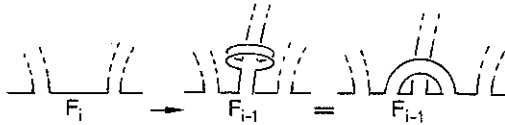

Fig. 17

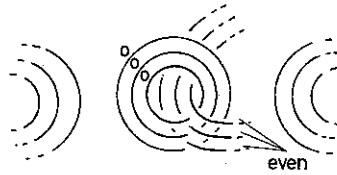

Fig. 18

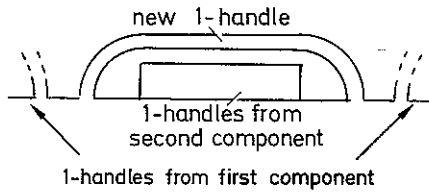

Fig. 19

trivial, linking 1-handle which can appear at either end of the first 1-handle; it is trivial because it is essentially β_i which bounds B_i (see Fig. 17).

The p -fold branched cover Q_{i-1} for F_{i-1} looks like Q_i for F_i , but with the addition of the framed link in Fig. 18 (drawn with $p=4$). The inner unknotted circle can be used to unlink its pair from everything else, to unknot its companion, and to change the even framing to zero (see Proposition 3 in [K2]); this gives the pair $^0\bigcirc\bigcirc^0$ which represents an $S^2 \times S^2$ in Q_{i-1} . We iterate this process, always using the innermost unknotted circle. Then Q_{i-1} differs from Q_i by the connected sum of $p-1$ copies of $S^2 \times S^2$. Since the number of handles in F_{i-1} is the same as in F_i except that the rank has increased by two, the theorem follows for F_{i-1} .

The case when α_0 and α_1 belong to the same closed component is similar, for the 2-handle produces the same 3-handles in Q_{i-1} as in Q_i .

Now suppose that α_0 and α_1 belong to different components of F_i , both of which have boundary. The picture for F_{i-1} is similar to Fig. 17 except that the long one-handle goes to another component. We can cancel this one-handle with the 0-handle of the other component, and redraw the surface as in Fig. 19. Then Q_{i-1} differs from Q_i in having $p-1$ less copies of $S^1 \times B^3$ and $p-1$ more copies of $S^2 \times B^2$ coming from the extra unknotted, untwisted, unlinking 1-handle. Since F_{i-1} differs from F_i by having one less 0-handle and one more 1-handle, the theorem again follows for F_{i-1} .

Finally, suppose that α_0 and α_1 belong to different components of F_i , at least one of which is closed. Then the two additional 1-handles in F_{i-1} that come from the surgery on F_i cancel one of the 0-handles as before, and also the 2-handle in one of the closed components. Thus Q_{i-1} differs from Q_i by having $p-1$ less $S^1 \times B^3$'s and $p-1$ less $S^3 \times B^1$'s, and F_{i-1} has one less 0-handle and one less 2-handle, so the theorem follows for F_{i-1} . By induction, we are done.

Theorem 4.1B (The Non-Orientable Case). *Let F be a non-orientable surface in ∂B^4 and suppose that ∂F is the unlink (of $s_0 + n - s_2$ components). Then the 2-fold branched cover of B^4 along F is*

$$Q = B^4 \# \left[\# (s_0 - 1) S^1 \times B^3 \right] \# \left[\# n S^2 \times B^2 \right] \\ \# \left[\# s_2 S^3 \times B^1 \right] \# \left[\# u CP^2 \# v (-CP^2) \right]$$

where $u + v = r$.

Proof. First we span each component of ∂F with a 2-ball. We can assume that these 2-balls meet F transversely in circles in $\text{int } F$ and in arcs; these arcs are properly imbedded in F and the 2-balls, but are transverse intersections only on their interiors (see Fig. 20). For each arc A in a 2-ball D , we remove from both F and D a strip of the form $\text{int } A \times (-1, 1)$. The remainder of F , called F_0 , is an oriented Seifert surface for its boundary which is still the unlink. Spanning 2-balls for ∂F_0 can be constructed; e.g. to the remainder of D , sew in a square $[-1, 1] \times [-1, 1]$ as in Fig. 21, to get a new 2-ball D' .

Now, as in the orientable case, we surger F_0 until it consists of 2-balls, 2-spheres minus 2-balls; call this surface F_{00} . The 2-fold cover of F_{00} is known, so we add the non-orientable one-handles to F_{00} and then undo the surgeries. Each 2-ball D may contain several arcs, A_1, \dots, A_k . So we add k one handles, each with a left or right half twist to $\partial D'$ as in Fig. 22. These one-handles undo the removal of $\text{int } A \times (-1, 1)$. Since these one-handles essentially lie next to D' , they do not link each other, and may be slid over to the left (see Fig. 22). Then it is clear that they contribute $\# u CP^2 \# v (-CP^2)$ to the branched cover where u is the number of one-handles with a half right twist and v those with a half left twist.

As in the orientable case, a surgery either connects components or adds on a torus to F_{00} ; both cases are treated as before. We must only note that when a torus is connected summed to F_{00} , then the 2-fold cover changes by $S^2 \times S^2$, and in the presence of a $\pm CP^2$, this is the same as connected summing with $CP^2 \# (-CP^2)$ (see [K2], Proposition 2).

Corollary 4.2. *Let P^4 be the 4-manifold constructed by plumbing on a graph. Suppose ∂P^4 is a homotopy 3-sphere. Then P^4 is diffeomorphic to $(\# k S^2 \times S^2) - \text{int } B^4$ or to $(\# k CP^2 \# l (-CP^2)) - \text{int } B^4$; the former occurs when the weights or framings on the graph are all even, the latter when some are odd. (For an independent proof, see [NW].)*

Proof. Since ∂P^4 is a homotopy 3-sphere, the graph can have no cycles, i.e. it is simply connected and is called a tree. Plumbing on a tree can always be described by a framed link which has an involution τ (see end of Sect. 2) as indicated in Fig. 23. Such a 4-manifold is a double branched cover of B^4 , branched over a surface F which "looks like" the top half of the framed link (again see Fig. 23). Thus ∂P is the double branched cover of S^3 over ∂F . Since ∂P is a homotopy sphere, we know from [R] and [S1] that $\partial P = S^3$. Also, ∂F has only one

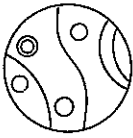

Fig. 20

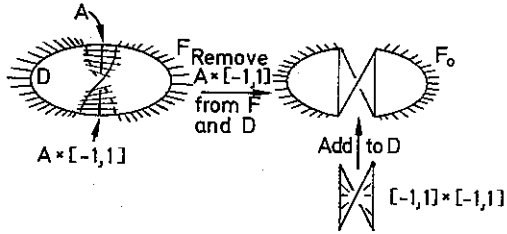

Fig. 21

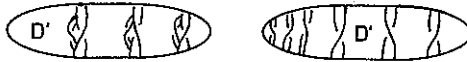

Fig. 22

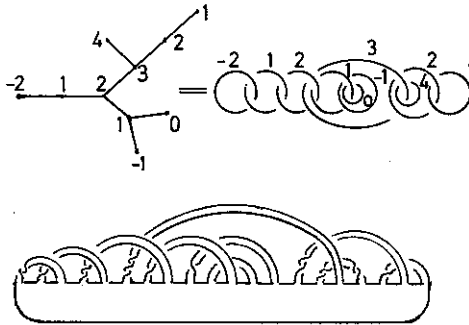

Fig. 23

component, for otherwise $H_1(\partial P) \neq 0$. By [W] it follows that ∂F is the unknot. The Corollary now follows from the theorem.

Corollary 4.3. *Suppose \bar{F} is a closed surface of k components imbedded in S^4 and consists of a surface F in S^3 with ∂F the unlink and some trivial 2-balls in the 4-handle of S^4 . Then the p -fold branched cover of S^4 along \bar{F} is*

$$\# g(p-1)S^1 \times S^2 \# (k-1)(p-1)S^3 \times S^1 \text{ if } \bar{F} \text{ is orientable of genus } g$$

or

$$\# uCP^2 \# v(-CP^2) \# (k-1)S^3 \times S^1 \text{ if } \bar{F} \text{ is non-orientable, } p=2, \text{ and } u+v = \text{rank } H_1(\bar{F}; \mathbb{Z}_2).$$

5.

Now we consider the case of a connected surface F in CP^2 , such as complex curves of degree p . Recall that CP^2 is built from a 0-handle, a 2-handle $B^2 \times B^2$ attached to the unknot with framing one by an attaching map $\varphi: \partial B^2 \times B^2 \rightarrow S^3$ with $\varphi(S^1 \times 0) = \text{unknot} = \varphi$, and a 4-handle. We will assume that $F = F_0 \cup F_4$ where $F_0 \subset \partial(0\text{-handle})$ and $F_4 \subset \partial(4\text{-handle})$.

Since $\partial(0\text{-handle}) \cap \partial(4\text{-handle}) = S^3 - \varphi(S^1 \times B^2)$, we can assume using transversality that the only part of F not lying in $\partial(0\text{-handle})$ is some copies of B^2 lying in $\partial(4\text{-handle})$ of the form $B^2 \times q \subset B^2 \times S^1 \subset B^2 \times B^2 = 2\text{-handle}$. So we could redefine the decomposition of F as $F_4 = \bigcup_{i=1}^k B_i^2$ and $F_0 = F - \text{int } F_4$.

Since F is connected, we can find in F_0 some smooth, disjoint arcs β_i , $i = 1, \dots, k-1$, such that β_i joins B_i^2 to B_{i+1}^2 , and each β_i lies in $S^3 - \varphi(S^1 \times B^3)$. We can thicken each β_i to a band $\beta_i \times [-1, 1]$ in F_0 so that $\partial\beta_i \times [-1, 1]$ lies in $\partial B_i \cup \partial B_{i+1}$. Now we once again redefine the decomposition of F by transferring the bands $\beta_i \times [-1, 1]$, $i = 1, \dots, k-1$ to F_4 and letting $F_0 = F - \text{int } F_4$. The point to this is that F_4 now consists of one 2-ball in $\partial(4\text{-handle})$.

Then the p -fold branched cover of CP^2 along F consists of the p -fold cover of the 0-handle branched over F_0 (with $\text{int } F_0$ pushed in), the 2-handle (unbranched), and the 4-handle branched over an unknotted 2-ball. The 2-handle lifts to p 2-handles and the 4-handle to one 4-handle. The above argument works equally well for a surface F in a manifold M^4 built with more than one 2-handle, so we have proved the following theorem.

Theorem 5.1. *Let M^4 be a smooth 4-manifold built with one 0-handle, some 2-handles, and one 4-handle. Let F be a closed, connected surface, smoothly imbedded in M so that $F = F_0 \cup F_4$ with $F_i \subset \partial(i\text{-handle})$, $i = 0, 4$. Then the p -fold branched cover of M along F can be built with only one 0-handle, some 2-handles, and a 4-handle.*

Corollary 5.2. *The p -fold branched cover of CP^2 along any non-singular complex curve can be built without 1 and 3-handles.*

Proof. The curve has some degree d , in which case it is equivalent, under ambient isotopy, to the curve Φ given by $x^d + y^d + z^d = 0$. The equation $z = 0$ defines a complex line in CP^2 which we take to be $B^2 \times 0 \cup D$ where $B^2 \times 0$ is the cocore of the 2-handle and D is the trivial 2-ball that $S^1 \times 0$ bounds in the 4-handle. Then $\Phi \cap \{z = 0\}$ is d points and $\Phi \cap (CP^2 - \{z = 0\})$ is equivalent to the affine variety $x^d + y^d = \varepsilon$ in $\mathbb{C}^2 = (CP^2 - \{z = 0\})$. We can assume that our 0-handle is the unit 4-ball B^4 in \mathbb{C}^2 and that ε is relatively small. Then

$$(\mathbb{C}^2 - \text{int } B^4, S^3, B^4) \cap \{x^d + y^d = \varepsilon\} \cong (L \times [1, \infty), L, F'_0)$$

where L is the (d, d) -torus knot ($= d$ Hopf circles) and F'_0 is the Milnor fiber. But Milnor constructs an isotopy of F'_0 onto F_0 , the fibered Seifert surface for L in S^3 ([M2], p. 53). Thus we see Φ represented by a surface $F = F_0 \cup F_4$ where F_4 is d 2-balls. The corollary now follows from Theorem 5.1.

Corollary 5.3. *Any non-singular complex surface of degree d in CP^3 can be built without 1 and 3-handles.*

Proof. Such a surface is the d -fold branched cover of the non-singular complex curve of degree d in CP^2 .

Corollary 5.4. *Let $V_\varepsilon = \{w^p - Q(x, y) = \varepsilon\}$ be an affine variety in \mathbb{C}^3 with an isolated singularity at the origin where $Q(x, y)$ is a complex polynomial. Then for small enough $\varepsilon > 0$, $V_\varepsilon \cap B^6$ can be built with one 0-handle and some 2-handles.*

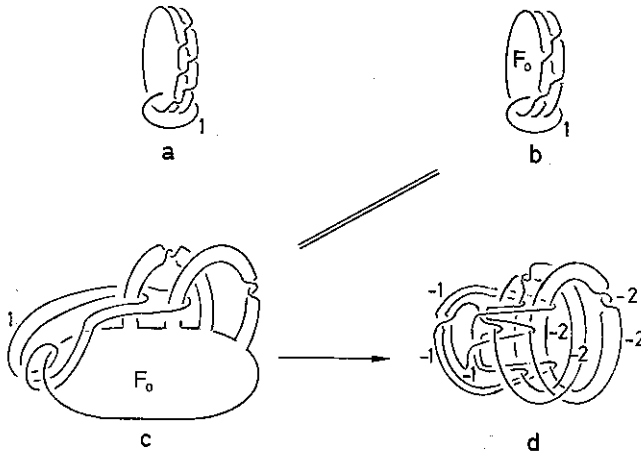

Fig. 24a-d

Proof. V_ε is the p -fold branched cover of the curve $\{Q(x, y) = \varepsilon\}$. But, once again, $\{Q(x, y) = \varepsilon\} \cap B^4$ can be isotoped onto the fibered Seifert surface F_0 of $\{Q(x, y) = \varepsilon\} \cap S^3$. Thus $V_\varepsilon \cap B^6$ will be the p -fold branched cover of B^4 along F_0 .

Corollaries 5.3 and 5.4 were independently proved in 1976 by Harer [H] by different methods, and Mandelbaum [M1] has proved Corollary 5.3 for complete intersections. Corollary 5.4 partially answers affirmatively a conjecture of Milnor ([M2], p. 58).

The arguments in the above proofs not only show the existence of handlebody decompositions without 1 and 3-handles, but indicate how to draw the framed links for the 2-handles. For example we do this for the complex surfaces V_d of degree d in CP^3 , $d = 3, 4, 5$.

V_3 is the 3-fold branched cover of the cubic in CP^2 . This cubic is represented by $F_0 \cup F_4$ where F_0 is the fibered Seifert surface for 3 Hopf circles, and F_4 is three 2-balls in $\partial(4\text{-handle})$ (see Fig. 24a and recall that φ is the attaching circle of the 2-handle). We can choose our bands, $\beta_1 \times [-1, 1]$ and $\beta_2 \times [-1, 1]$ to be two of the half twisted bands in Fig. 24a, so that when the bands are shifted to F_4 , then F_0 becomes the fibered Seifert surface for the $(2, 3)$ -torus knot (Fig. 24b), and F_4 is one 2-ball.

We redraw the Seifert surface F_0 as in Fig. 24c. When we cut B^4 along F_0 pushed into B^4 , φ is cut at 3 points. Then we glue together 3 copies of B^4 and fold down (as in Fig. 8) to get Fig. 24d. The attaching circle φ lifts to 3 circles, $\varphi_1, \varphi_2, \varphi_3$, which must be the attaching circles of the three lifts of the 2-handle of CP^2 . Thinking of φ_1, φ_2 and φ_3 as 2-dimensional homology classes, we get $(\varphi_1 + \varphi_2 + \varphi_3)^2 = 3\varphi^2 = 3$, since each self intersection poing in CP^2 lifts to three above. Or, by symmetry, $\varphi_1(\varphi_1 + \varphi_2 + \varphi_3) = 1$. But we compute (via linking) that $\varphi_1 \cdot \varphi_2 = \varphi_1 \cdot \varphi_3 = 1$, so $\varphi_1^2 = -1 = \varphi_2^2 = \varphi_3^2$.

This complex manifold, V_3 , is in fact diffeomorphic to $CP^2 \# 6(-CP^2)$, and it is instructive to slide handles so that Fig. 24d turns into seven unknotted, unlinked circles with one +1 and six -1 framings.

The 4-fold branched cover of the quartic in CP^2 is the Kummer surface; a detailed description of it is given in [HKK], and we describe it later as the 2-fold

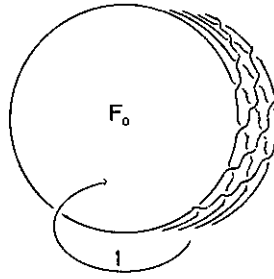

Fig. 25

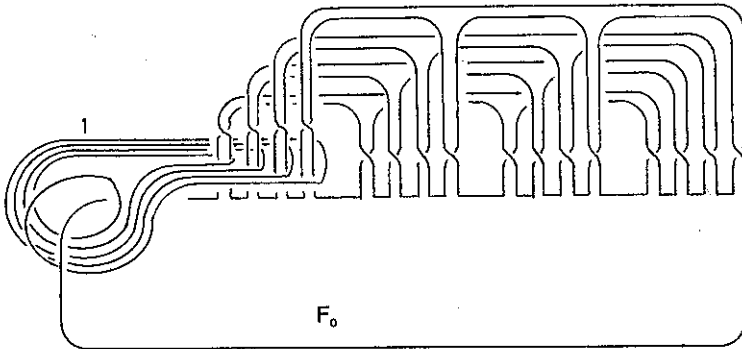

Fig. 26

branched cover over the sextic. We turn instead to the quintic which, in analogy with the cubic, is represented by a surface F which consists of the $(4, 5)$ -torus knot in S^3 , bounding its usual Seifert surface F_0 in B^4 , Fig. 25, and bounding a 2-ball F_4 in $\partial(4\text{-handle})$. We redraw F_0 , Fig. 26, and construct the 5-fold branched cover, Fig. 27. This manifold, the quintic surface, is obviously simply connected and has an odd, indefinite intersection form, so it is homotopy equivalent to $\# 9CP^2 \# 44(-CP^2)$ (see [MH]). Unlike the case of the cubic, the quintic is not known to be diffeomorphic to this connected sum of $(\pm CP^2)$'s. In fact, we are unable to decompose the quintic into any sort of connected sum, even $M^4 \# \pm CP^2$.

It is known [MM] that $V_5 \# CP^2$ is diffeomorphic to $\# 10CP^2 \# 44(-CP^2)$. We have not figured out how to blow up a $+1$ unknot in Fig. 27 so that by obvious handle sliding the framed link decomposes into the unlink, but a reasonable guess is to blow up the $+1$ unknot around one or more of the bands with the -1 full twist. This would immediately give some unlinked -1 unknots.

The quartic or Kummer surface (see [HKK]) is known to be the 2-fold branched cover of the sextic curve in CP^2 . In analogy with the cubic and quintic, the sextic can be described as the usual Seifert surface F_0 of the $(6, 5)$ -torus in S^3 which is capped off in CP^2 by a 2-ball in $\partial(4\text{-handle})$. Figure 28 shows the Seifert surface with the attaching map of the 2-handle. Figure 29 shows the 2-fold branched cover.

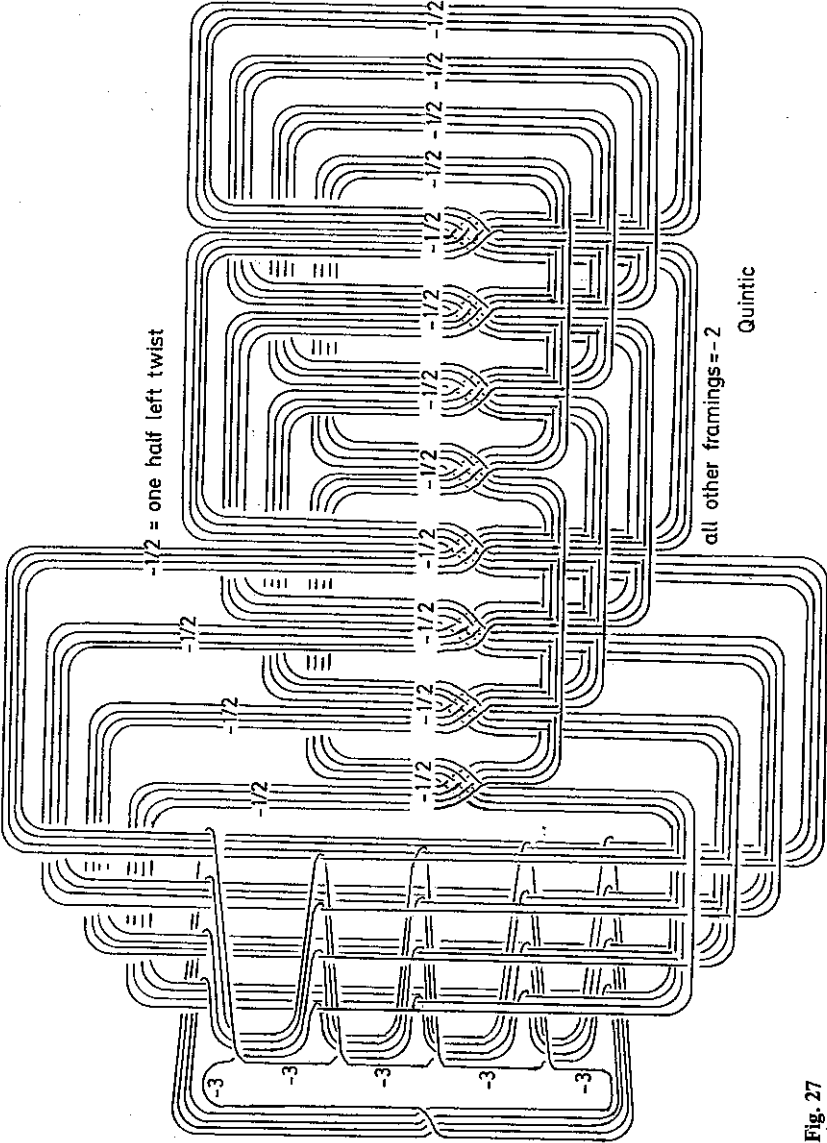

Fig. 27

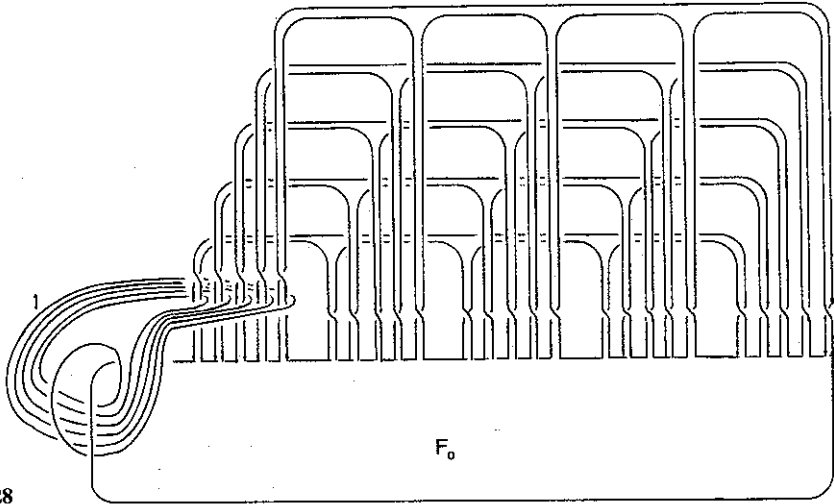

Fig. 28

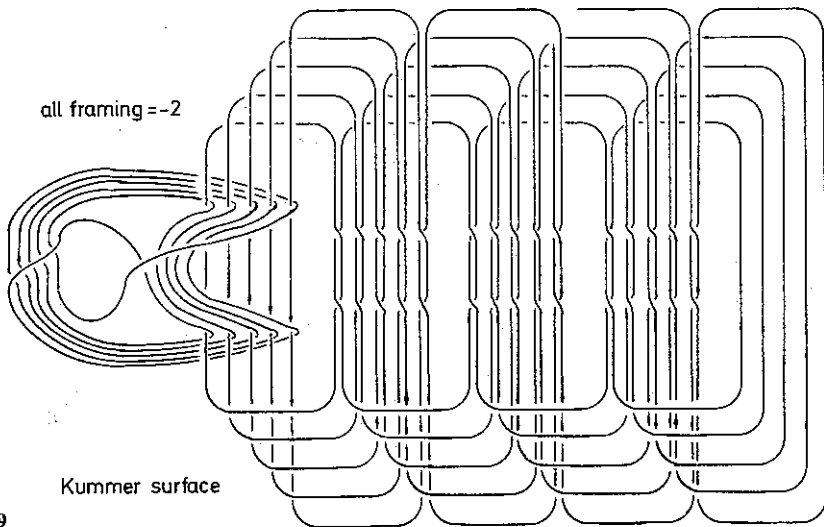

Fig. 29

A different handlebody decomposition for the Kummer surface along with the half-Kummer surface, and some logarithmic transforms (so far requiring 1 and 3-handles) will appear in [HKK].

Note that the second Betti number of the p -fold branched cover of CP^2 over a non-singular curve of degree p is $p - 1$ times twice the genus of the $(p, p - 1)$ -torus knot plus p , i.e. $(p - 1)^2(p - 2) + p = p^3 - 4p^2 + 6p - 2$. The index is given by $p(p^2 - 4)/3$.

References

- [BGM] Birman, J.S., González-Acuña, F., Montesinos, J.M.: Heegard splittings of prime 3-manifolds are not unique. *Michigan Math. J.* **23**, 97–103 (1976)
- [BS] Bonahon, F., Siebenmann, L.C.: Lectures, Berkeley 1979
- [F] Fox, R.H.: A note on branched cyclic coverings of spheres. *Rev. Mat. Hisp.-Amer.* **32**, 158–166 (1972)
- [G] Giller, C.: A family of links and the Conway calculus (to appear in *Trans. Amer. Math. Soc.*)
- [GL] Gordon, C.McA., Litherland, R.L.: To appear
- [H] Harer, J.: On handlebody structures for hypersurfaces in C^3 and CP^3 . *Math. Ann.* **238**, 51–58 (1978)
- [HKK] Harer, J., Kas, A., Kirby, R.: Handlebody decompositions for complex surfaces
- [KT] Kauffman, L., Taylor, L.: Signature of links. *Trans. Am. Math. Soc.* **216**, 351–365 (1976)
- [K1] Kirby, R.: Problems in low dimensional manifold theory. *Proc. Sym. Pure Math.* **32**, 273–312 (1976)
- [K2] Kirby, R.: A calculus for framed links in S^3 . *Invent. Math.* **45**, 35–56 (1978)
- [KS] Kirby, R., Scharlemann, M.: Eight faces of the Poincaré homology sphere. In: *Geometric topology*, pp. 113–146. New York: Academic Press 1979.
- [K3] Kuiper, N.H.: The quotient space of CP^2 by complex conjugation is the 4-sphere. *Math. Ann.* **208**, 175–177 (1974)
- [M1] Mandelbaum, R.: Special handlebody decompositions of simply connected algebraic surfaces (to appear in *Proc. Amer. Math. Soc.*)
- [MM] Mandelbaum, R., Moishezon, B.: On the topological structure of non-singular algebraic surfaces in CP^3 . *Topology* **15**, 23–40 (1976)
- [M2] Milnor, J.: Singular points of complex hypersurfaces. In: *Annals of Mathematical Studies* No. 61. Princeton: Princeton University Press 1968
- [MH] Milnor, J., Husemoller, D.: *Symmetric bilinear forms*. Berlin, Heidelberg, New York: Springer 1973
- [NW] Neumann, W., Weintraub, S.: Four-manifolds constructed via plumbing
- [R] Von Randow, E.: Zur Topologie von Dreidimensionalen Baummannigfaltigkeiten. *Bonn. Math. Schr.* **14** (1962)
- [S1] Scharf, A.: Zur Faserung von Graphenmannigfaltigkeiten. *Math. Ann.* **215**, 35–45 (1975)
- [S2] Schubert, H.: Knoten mit zwei Brücken. *Math. Z.* **65**, 113–170 (1956)
- [T] Trotter, H.F.: Some knots spanned by more than one unknotted surface of minimal genus. In: *Annals of Mathematical Studies*, No. 84, pp. 51–62. Princeton: Princeton University Press 1975
- [W] Waldhausen, F.: Über Involutionen der 3-Sphäre. *Topology* **8**, 81–91 (1969)

Received April 24, 1979, in revised form January 31, 1980

